

LI10600T070IA3098

7.0 inch, 1024*600 pixels resolution, RGB interface, IPS-TFT-LCD

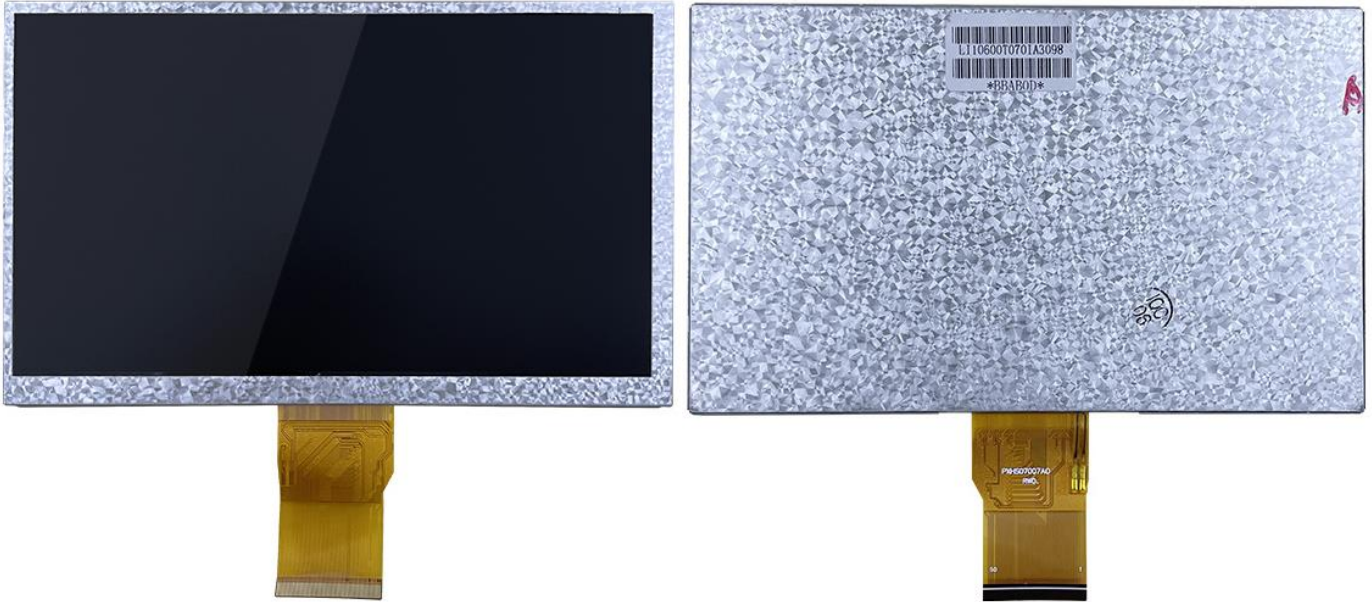

Disclaimer: The product design is subject to alternation and improvement without prior notice.

Table of Contents

1 General Feature.....	3
2 Mechanical Drawing.....	4
3 Input/Output Terminals.....	5
4 Electrical Characteristics.....	6
5 Timing Characteristics.....	7
6 Optical Characteristics.....	10
7 Environmental Reliability Test.....	15
8 Packing Capacity & Dimension.....	16
9 Appearance Inspection.....	17
10 Precautions for Use of LCD Modules.....	20
11 LCD Introduction.....	21

1 General Feature

Feature		Description	Unit
Display Spec.	Size	7.0	inch
	Resolution	1024(H)*600(V)	pixels
	Pixel Configuration	RGB stripe	-
	Pixel Pitch	0.0502(H)*0.1432(V)	mm
	Viewing Direction	ALL	-
Mechanical Characteristics	Outside Dimension	165.0(W)*100.0(H)*3.5(D)	mm
	Active Area	154.21(W)*85.92(H)	mm
	Luminance	300	cd/m ²
	LED Numbers	21 LEDS	-
	Pin Order	From left to right 50PIN	-
	Weight	150	g
Electrical Characteristics	Interface	RGB	-
	Color Depth	16.7M	colors
	Driver Condition	-	V
	Driver IC	HX8282-A11DPD300+HX8696-A01APD300 EK79001HK + EK73215BCGA	-
Temperature Range	Operating Temp.	-20~70	°C
	Storage Temp.	-30~80	°C

Note: Requirements on Environmental Protection: RoHS.

You can use dynamic screen saver wallpapers to avoid afterimages caused by fixed paper display for a long time.

2 Mechanical Drawing

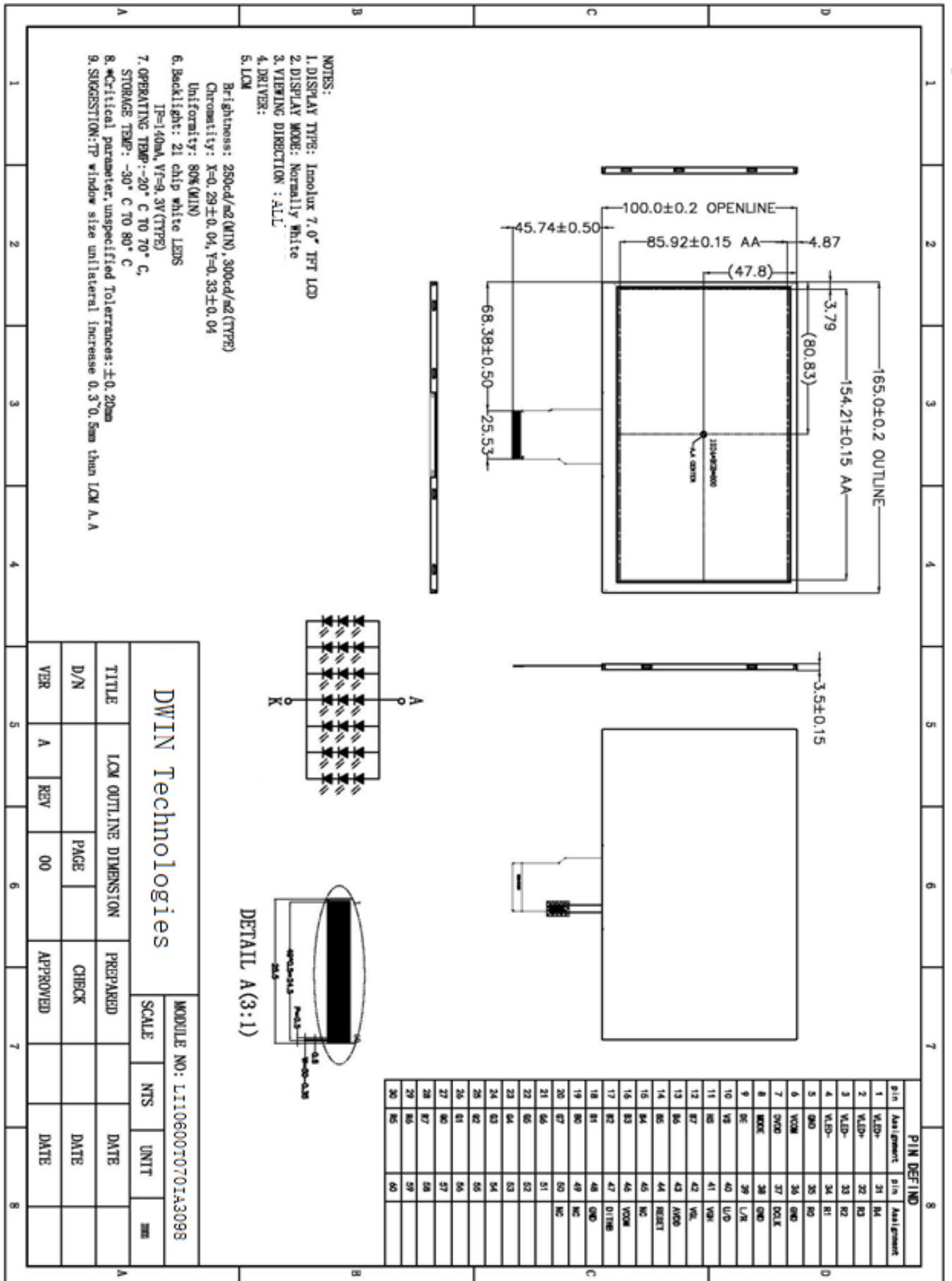

DWIN

3 Input/Output Terminals

Pin NO.	Symbol	Function	Remark
1	VLED+	Power for LED backlight (Anode)	
2	VLED+	Power for LED backlight (Anode)	
3	VLED-	Power for LED backlight (Cathode)	
4	VLED-	Power for LED backlight (Cathode)	
5	GND	Power ground	
6	VCOM	Common voltage	
7	DVDD	Power for Digital Circuit	
8	MODE	DE/SYNC mode select	
9	DE	Data Input Enable	
10	VS	Vertical Sync Input	
11	HS	Horizontal Sync Input	
12-19	B7-B0	Blue data	
20-27	G7-G0	Green data	
28-35	R7-R0	Red data	
36	GND	Power Ground	
37	DCLK	Sample clock	
38	GND	Power Ground	
39	L/R	Left / right selection	
40	U/D	Up/down selection	
41	VGH	Gate ON Voltage	
42	VGL	Gate Off Voltage	
43	AVDD	Power for Analog Circuit	
44	RESET	Global reset pin.	
45	NC	No connection	
46	VCOM	Common Voltage	
47	DITHB	Dithering function	
48	GND	Power Ground	
49	NC	No connection	
50	NC	No connection	

Note 1: DE/SYNC mode select. Normally pull high. When select DE mode, MODE= "1", VS and HS must pull high. When select SYNC mode, MODE= "0", DE must be grounded.

Note 2: When input 18 bits RGB data, the two low bits of R, G and B data must be grounded.

Note 3: Data shall be latched at the falling edge of DCLK.

Note 4: Definition of scanning direction. Refer to the figure as below.

Note 5: Global reset pin. Active low to enter reset state. Suggest to connect with an RC reset circuit for stability. Normally pull high.

Note 6: Dithering function enable control, normally pull high. When DITHB= "1", disable internal dithering function, When DITHB="0", enable internal dithering function,

4 Electrical Characteristics

4.1 Driving TFT LCD Panel

Item	Symbol	Min.	Typ.	Max.	Unit	Remark
TFT Gate On Voltage	VGH	-	17	-	V	
TFT Gate Off Voltage	VGL	-	-7	-	V	
TFT Common Electrode Voltage	VCOM	3.26	3.76	4.26	V	
Analog Power	AVDD	9.3	9.6	10.4	V	

4.2 LED Backlight Specification

Item	Symbol	Min.	Typ.	Max.	Unit	Remark
Forward Voltage	VF	9	9.3	9.6	V	IF=140mA
Forward Current	IF	-	140	-	mA	
Luminance	Lv	-	300	-	cd/m ²	IF=140mA
Uniformity(with L/G)	Avg	75	80	-	%	

Note: 21 LEDs (3 LEDs Serial, 7 ways Parallel)

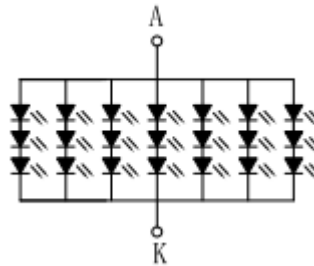

5 Timing Characteristics

5.1 Power On/Off sequence

5.1.1 Power On

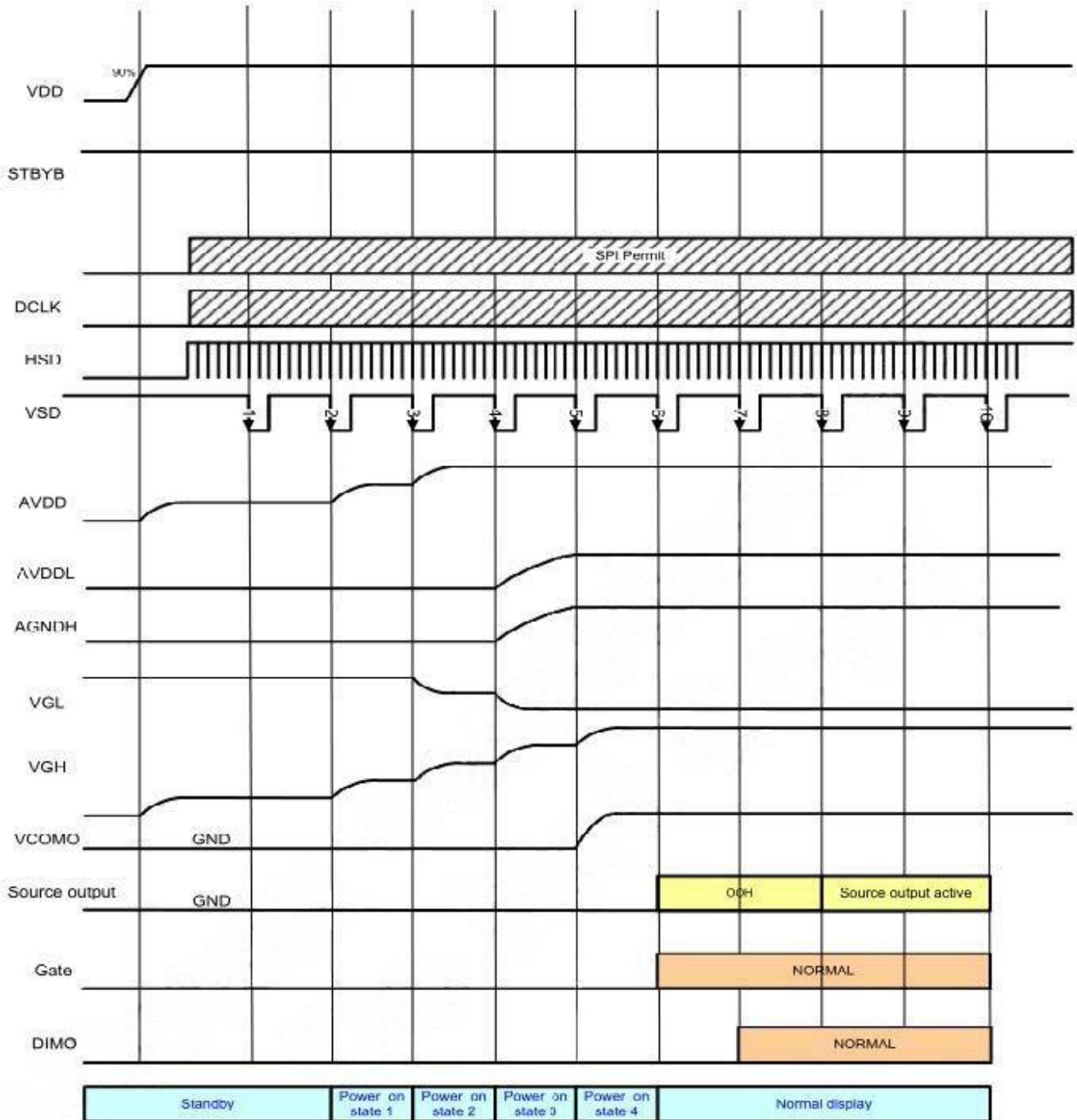

5.1.2 Power Off

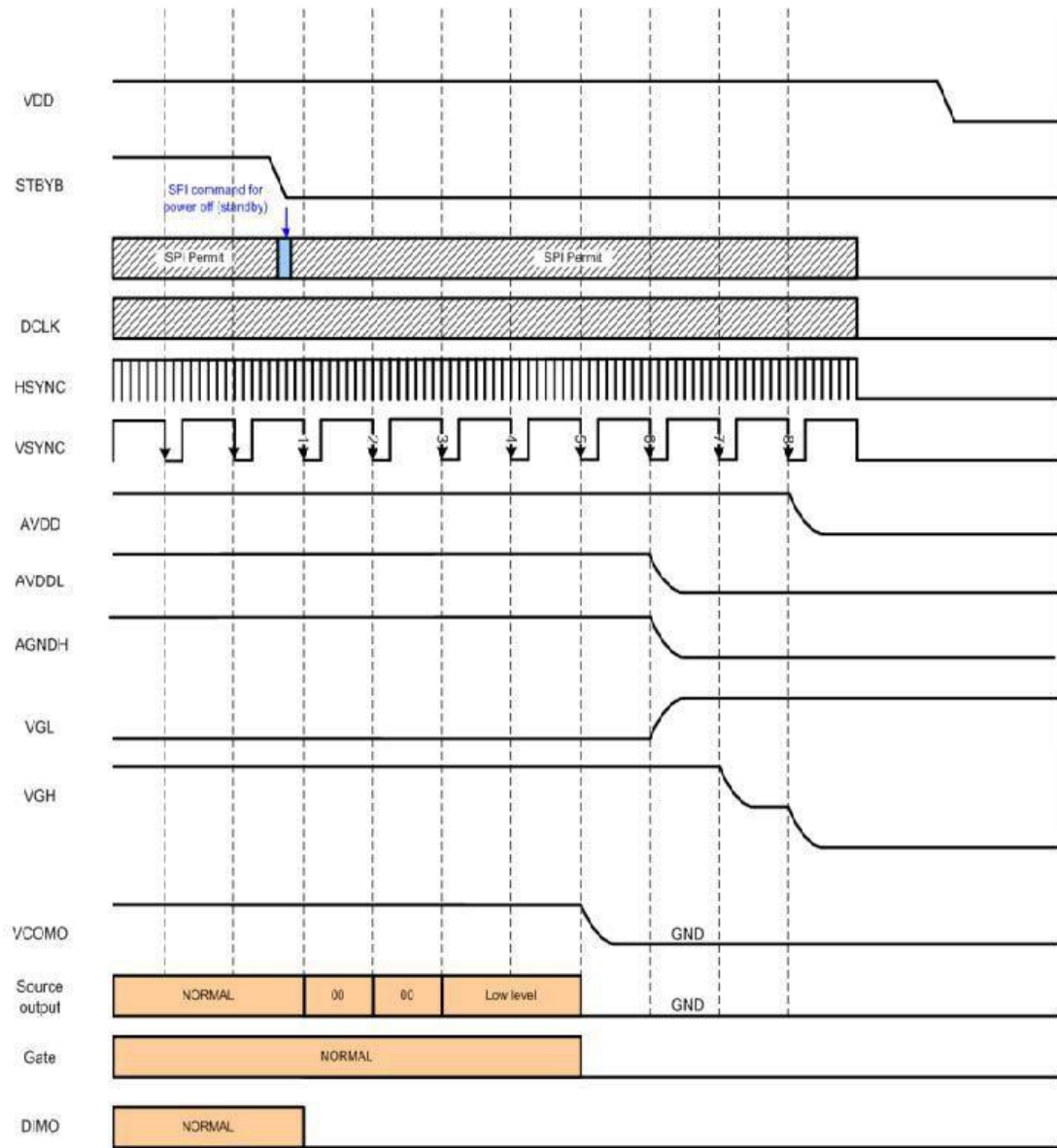

Note: (1) Low level=3FH, when NBW=L. (Normally white)
(2) Low level=00H, when NBW=H. (Normally black)

5.2 AC Electrical Characteristics

Item	Symbol	Min.	Typ.	Max.	Unit	Remark
HS setup time	Thst	8.0	-	-	nS	
HS hold time	Thhd	8.0	-	-	nS	
VS setup time	Tvst	8.0	-	-	nS	
VS hold time	Tvhd	8.0	-	-	nS	
Data setup time	Tdsu	8.0	-	-	nS	
Data hold time	Tdhd	8.0	-	-	nS	
DE setup time	Tesu	8.0	-	-	nS	
DE hold time	Tehd	8.0	-	-	nS	
DVDD power on slew rate	TPOR	-	-	20	mS	From 0 to 90% DVDD
RESET pulse width	TRst	1	-	-	mS	
DCLK cycle time	Tcoh	20	-	-	nS	
DCLK pulse duty	Tcwh	40	50	60	%	

5.3 Input Clock and Data Timing Diagram

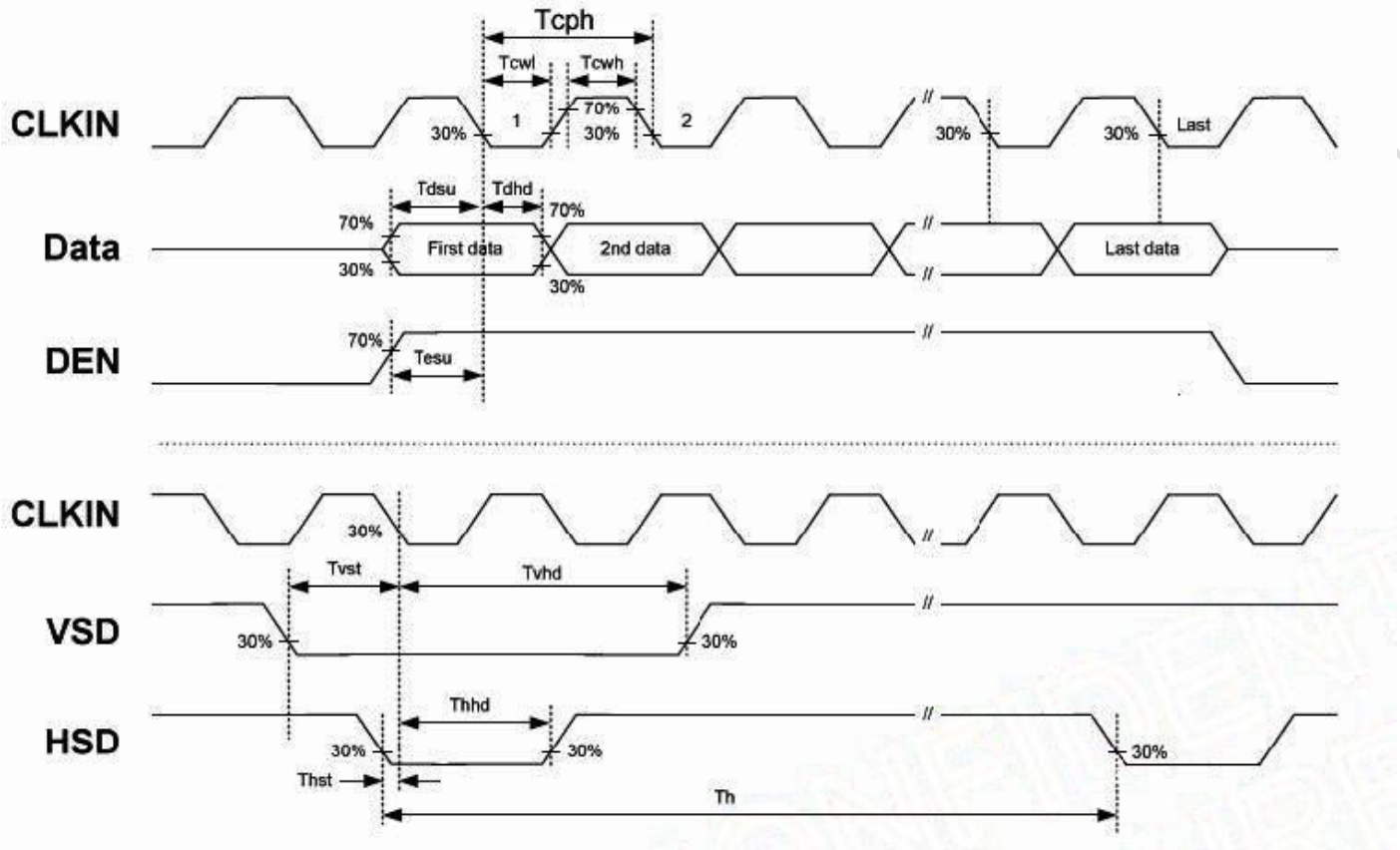

5.4 Timing

Item	Symbol	Min.	Typ.	Max.	Unit	Remark
Horizontal display area	thd	-	1024	-	DCLK	
DCLK frequency	fclk	40.8	51.2	67.2	MHz	
One horizontal line	th	1114	1344	1400	DCLK	
HS pulse width	thpw	1	-	40	DCLK	
HS blanking	thb	46	46	46	DCLK	
HS front Porch	thfp	10	35	200	DCLK	

Item	Symbol	Min.	Typ.	Max.	Unit	Remark
Vertical display area	tvd	-	600	-	TH	
VS period time	tv	624	635	750	TH	
VS pulse width	tvpw	1	-	20	TH	
VS blanking	tvb	23	23	23	TH	
VS front porch	tvfp	1	12	127	TH	

5.5 Data Input Format

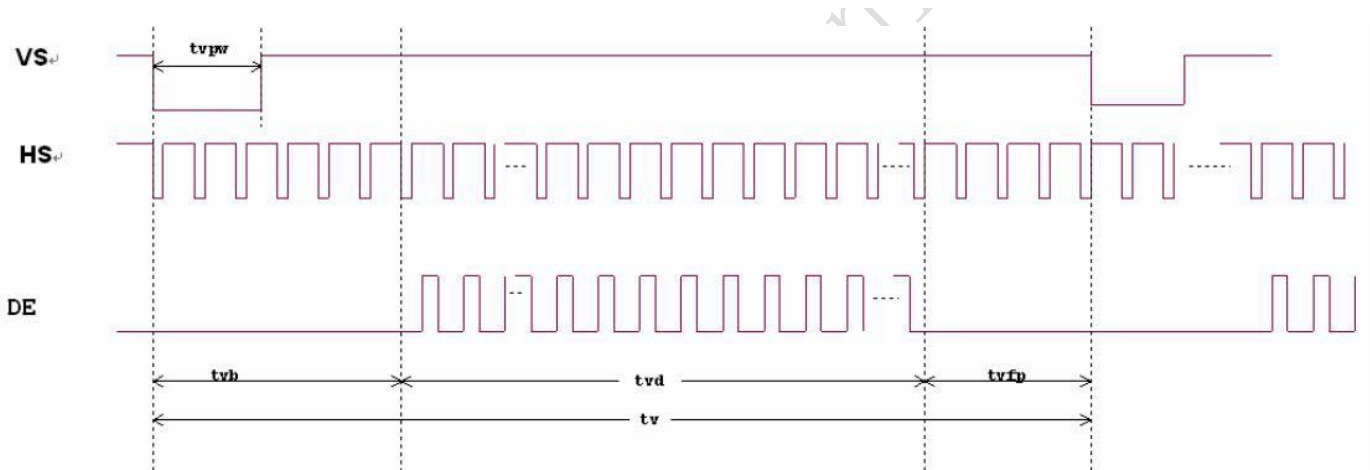

6 Optical Characteristics

Item	Symbol	Condition	Min.	Typ.	Max.	Unit	Remark
Viewing Angle	Top	$CR \geq 10$	-	80	-	Deg.	Note 2,3
	Bottom		-	80	-		
	Left		-	80	-		
	Right		-	80	-		
Contrast Ratio	CR	$\theta=0^\circ$	800	1000	-		Note 3
Response Time	T_{ON}	$\theta=0^\circ$	-	10	20	ms	Note 3
	T_{OFF}		-	15	30	ms	
Color Chromaticity	W_x		0.272	0.292	0.332		Note 1,5
	W_y		0.298	0.302	0.358		
Luminance	L		250	300	-	cd/m ²	
Uniformity(with L/G)	YU		75	80	-	%	

Test conditions:

IF= 140 mA, and the ambient temperature is 25°C.

Note 1: Definition of optical measurement system.

The optical characteristics should be measured in dark room. After 5 minutes operation, the optical properties are measured at the center point of LCD.

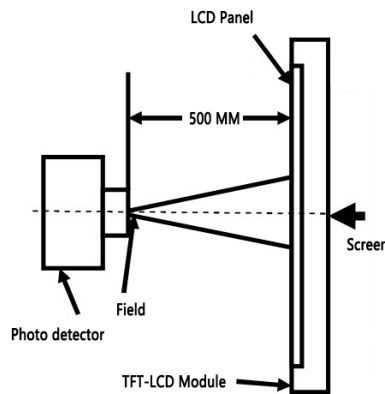

Note 2: Definition of viewing angle range and measurement system.

The viewing angle is measured at the center point of the LCD by BM-7A.

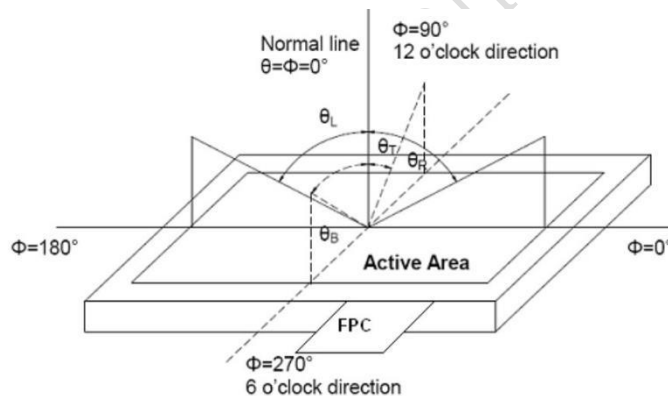

Note 3: Definition of contrast ratio.

$$\text{Contrast ratio (CR)} = \frac{\text{Luminance measured when LCD is on the "White" state}}{\text{Luminance measured when LCD is on the "Black" state}}$$

“White state “: The state is that the LCD should drive by V_{white} .

“Black state”: The state is that the LCD should drive by V_{black} .

V_{white} : To be determined V_{black} : To be determined.

Note 4: Definition of response time.

The response time is defined as the LCD optical switching time interval between “White” state and “Black” state. Time ON (TON) is the time between photo detector output intensity changed from 90% to 10%. And time off (TOFF) is the time between photo detector output intensity changed from 10% to 90%.

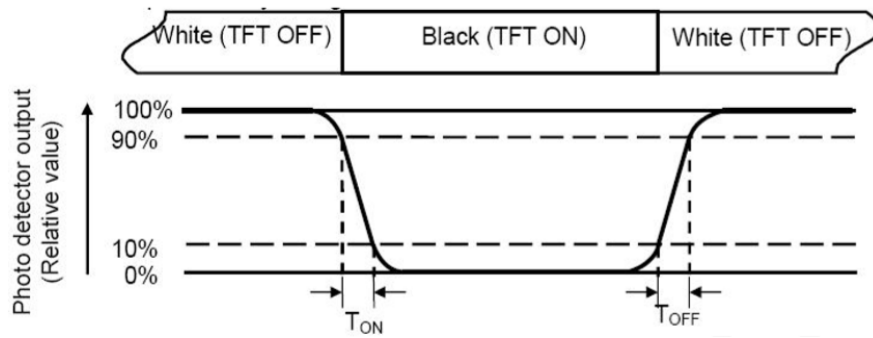

Note 5: Definition of color chromaticity (CIE1931).
Color coordinates measured at center point of LCD.

Note 6: Definition of luminance uniformity.

Active area is divided into 9 measuring areas (Refer Fig. 2). Every measuring point is placed at the center of each measuring area.

$$\text{Luminance Uniformity (U)} = L_{\min} / L_{\max}$$

L-----Active area length W----- Active area width

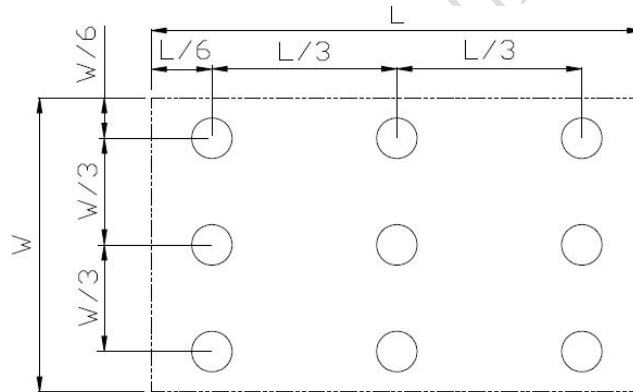

L_{\max} : The measured Maximum luminance of all measurement position.

L_{\min} : The measured Minimum luminance of all measurement position.

Note 7: Definition of luminance.

Measure the luminance of white state at center point.

7 Environmental Reliability Test

NO	Test Item	Condition	Remarks
1	High Temperature Operation	Ta=+70℃,240hours	IEC60068-2-1:2007 GB2423.2-2008
2	Low Temperature Operation	Ta=-20℃,240hours	IEC60068-2-1:2007 GB2423.1-2008
3	High Temperature Storage	Ta=+80℃,240hours	IEC60068-2-1:2007 GB2423.2-2008
4	Low Temperature Storage	Ta=-30℃,240hours	IEC60068-2-1:2007 GB2423.1-2008
5	Storage at High Temperature and Humidity	Ta=+60℃,90% RH max,240hours	IEC60068-2-78 :2001 GB/T2423.3-2006
6	Thermal Shock (non-operation)	-30℃ 30 min~+85℃ 30 min, for a total 100cycles, Start with cold temperature and end with high temperature.	Start with cold temperature, End with high temperature, IEC60068-2-14:1984, GB 2423.22-2002
7	ESD(non-operation)	± 2KV, Human Body Mode, 100pF/1500Ω	IEC61000-4-2:2001 GB/T 17626.2-2006
8	Vibration Test	Frequency range:10~55Hz Stroke:1.5mm Sweep:10Hz~55Hz~10Hz 2 hours for each direction of X.Y.Z. (6 hours for total)	IEC60068-2-6:1982 GB/T 2423.10-1995
9	Mechanical Shock (non-operation)	Half Sine Wave 60G 6ms, ±X, ±Y, ±Z 3times for each direction	IEC60068-2-27:1987 GB/T 2423.5-1995
10	Package Drop Test	Height:60cm,1corner,3 edges,6 surfaces	IEC60068-2-32:1990 GB/T 2423.8-1995

8 Packing Capacity & Dimension

Dimension			
Dimension(mm)	165.0(W)*100.0(H)*3.5(D)		
Net Weight	150g		
Packing Capacity			
Size	LCD Size and Resolution	Layer	Quantity(Pcs)
250mm(L)x200mm(W)x80mm(H)	7.0 inch 1024*600	1	1
600mm(L)x430mm(W)x290mm(H)	7.0 inch 1024*600	1	80

Packing instruction:

The LCD is placed in the grid, covered with a PE static bag and compactly assembled, the upper and the lower layers of the grid are protected by buffer spaces.

The LCD covered with a PE static bag and compactly assembled



placed in the grid



The upper and the lower layers of the grid are protected by buffer spaces



Packed



9 Appearance Inspection

9.1 General rules for inspection

9.1.1 Anti-static wearables (anti-static wristbands, gloves) must be worn during the inspection.

9.1.2 Do not use bare hands to touch the position of the device, golden fingers, and the surface of the screen to prevent the sweat from human hands from causing oxidation and affecting the appearance.

9.1.3 It is forbidden to stack products out of specification and handle them with care to avoid damage to components.

9.1.4 The repaired products need to be inspected to prevent rosin and tin slag from exceeding the specifications.

9.1.5 When technical documents and process documents have specific requirements for products, the technical documents and process documents shall be the main requirements.

9.2 Inspection conditions

9.2.1 The conditions of display function check

Angle: $\pm 5^\circ$;

Inspection method: visual inspection. The inspection object is 30-40cm away from the light source, and the eye is 30-40cm away from the inspection object;

Illumination: 300-500Lux;

Inspection time: 5-10S.

9.2.2 Visual inspection conditions

Angle: $\pm 45^\circ$;

Inspection method: visual inspection. The inspection object is 30-40cm away from the light source, and the eye is 30-40cm away from the inspection object;

Illumination: 800-1500Lux;

Inspection time: 5-10S.

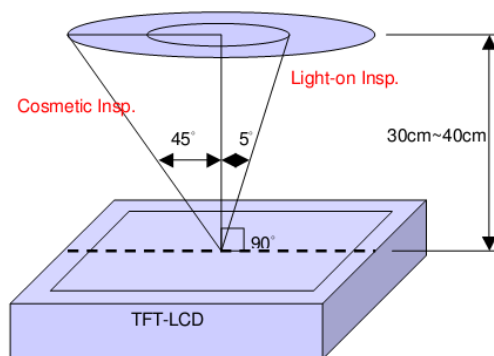

9.3 Inspection standards

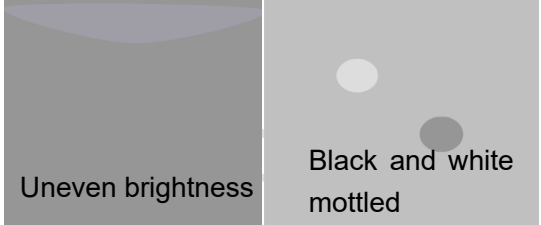
Type	Test Items	Judgement Standard	Defect Category
Display state	Dead pixels	No dead pixels	
	mura	<p>From different angles, the brightness is required to be uniform. Under the 64-level grayscale or pure black interface, there should be no uneven display brightness within the viewing angle range of 45° through 6% ND FILTER. Y series (TV film) LCD screen does not have specific requirements, and the picture inspection does not affect the display as qualified.</p> 	Slight defect
	Light leakage	<p>Under the 64-level grayscale or pure black interface, there should be no obvious light leakage within the viewing angle range of 45° by visual inspection or through 6% ND FILTER. Y series (TV LCD screen) series can be without obvious visual defects.</p>	Slight defect
	Linear foreign bodies	<p>1. $W \leq 0.05$, $L \leq 2\text{mm}$, negligible; 2. $0.05\text{mm} < W \leq 0.1\text{mm}$, $L \leq 2\text{mm}$, $N \leq 3$; 3. $W > 0.1\text{mm}$, $L > 2\text{mm}$, not allowed.</p>	Slight defect
Screen surface	Within the effective area	<p>Spotted: 1. $D \leq 0.2\text{mm}$ and it is not a piece, it is not counted; 2. $0.2\text{mm} < D \leq 0.5\text{mm}$, $N \leq 3$; 3. $D > 0.5\text{mm}$, $L > 0.5\text{mm}$, $W > 0.5\text{mm}$ are not allowed; (The spotted foreign objects shall not exceed the point-line gauge $D=0.5$, and the black dot coverage shall be checked, and the spotted foreign objects shall be judged within the range of $D=0.5$)</p>	Slight defect

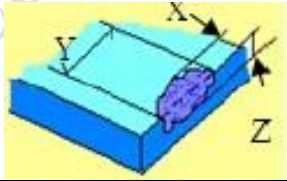
	Foreign objects Scratch Air bubbles	Linear: 1. $W \leq 0.05$, $L \leq 2\text{mm}$, ignored; 2. $0.05 < W \leq 0.1\text{mm}$, $L \leq 2\text{mm}$, $N \leq 3$; 3. $W > 0.1\text{mm}$, $L > 2\text{mm}$, not allowed.	
	Outside the effective area Foreign objects Scratches Air bubbles	Foreign objects are not checked, and bubbles are not allowed to $D > 1\text{mm}$; Non-inductive scratches of no more than $0.1 \times 8\text{mm}$ are allowed.	Slight defect
	Crack	Not allowed.	 Slight defect
	Notch	1. Does not affect the appearance from the front; 2. Does not affect the relevant alignment; 3. $X \leq 1\text{mm}$, $Y \leq 1\text{mm}$, $N \leq 2$.	 Slight defect
	Glass side Foreign objects Dirty	1. The foreign body on the side is not controlled; 2. The paint pen marks on the side are not controlled; 3. Side oily note printing is not allowed.	Slight defect
FPC	Cracks Goldfinger crease	Not allowed.	Heavy deficit
	Crease	Slight creases are not controlled; The crease is whitish and has lines, which is not allowed.	Heavy deficit
	Top wound, stab wound	No damage to the line, $D \leq 0.2\text{mm}$; Damage to the line is not allowed.	Heavy deficit
	Scratch	Slight scratches on the surface are not controlled; Damage to the line is not allowed.	Heavy deficit
	Goldfinger scratch	$W \leq 0.05\text{mm}$, no control; $W > 0.05\text{mm}$, not allowed; Test probe tip marks are not controlled.	Heavy deficit
	Component	Under-soldering, over-soldering and false soldering are not allowed.	Heavy deficit

10 Precautions for Use of LCD Modules

10.1 Handling Precautions

10.1.1 The display panel is made of glass. Do not subject it to a mechanical shock by dropping it from a high place, etc.

10.1.2 If the display panel is damaged and the liquid crystal substance inside it leaks out, be sure not to get any in your mouth, if the substance comes into contact with your skin or clothes, promptly wash it off using soap and water.

10.1.3 Do not apply excessive force to the display surface or the adjoining areas since this may cause the color tone to vary.

10.1.4 The polarizer covering the display surface of the LCD module is soft and easily scratched. Handle this polarizer carefully.

10.1.5 If the display surface is contaminated, breathe on the surface and gently wipe it with a soft dry cloth. If still not completely clear, Can only use LCD dedicated cleaner, the following organic solvent can not be used:

- Isopropyl alcohol
- Ethyl alcohol
- Ketone
- Aromatic solvents

10.1.6 Do not attempt to disassemble the LCD Module.

10.1.7 If the logic circuit power is off, do not apply the input signals.

10.1.8 To prevent destruction of the elements by static electricity, be careful to maintain an

10.1.9 optimum work environment.

10.1.9.1 Be sure to ground the body when handling the LCD Modules.

10.1.9.2 Tools required for assembly, such as soldering irons, must be properly ground.

10.1.9.3 To reduce the amount of static electricity generated, do not conduct assembly and other work under dry conditions.

10.1.9.4 The LCD Module is coated with a film to protect the display surface. Be care when peeling off this protective film since static electricity may be generated.

10.2 Storage precautions

10.2.1 When storing the LCD modules, avoid exposure to direct sunlight or to the light of fluorescent lamps.

10.2.2 The LCD modules should be stored under the storage temperature range. If the LCD modules will be stored for a long time, the recommend condition is:

Temperature: 0°C ~ 40°C Relatively humidity: ≤80%.

10.2.3 The LCD modules should be stored in the room without acid, alkali and harmful gas.

10.3 Transportation Precautions

10.3.1 The LCD modules should be no falling and violent shocking during transportation, and also should avoid excessive press, water, damp and sunshine.

11 LCD Introduction

11.1 Process capacity

DWIN adopts original class A glass and the entire production is in the park from cleaning, cutting, bonding, and laminating of large glass to backlight assembly, quality inspection, and aging.

There are 12,000 square meters of clean workshop, with a monthly production capacity of about 2.5 million pieces. Each piece of LCD produced in the factory is for 30 days of aging.



11.2 ODM service

Based on LCD products of 1.5~21.5 inches, DWIN provides the following customization services.

1、LCD HDMI interface customization.

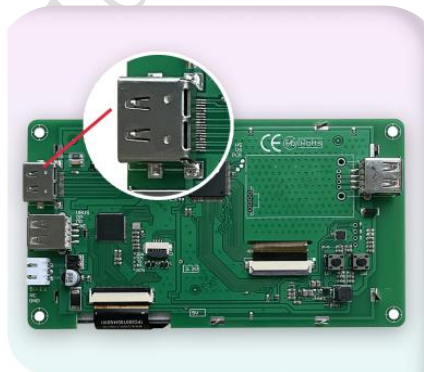

HDMI interface

2、Special screen customization such as high brightness, ultra-wide temperature and strong electromagnetic protection.

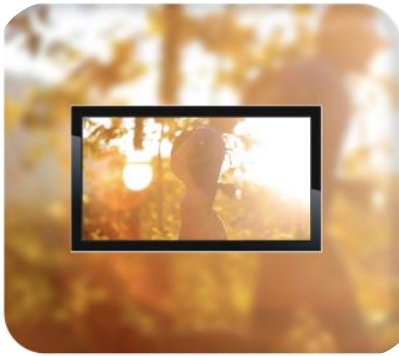

High luminance
(up to 1200nit)



Ultra-wide temperature
(-40~85℃)



Strong electromagnetic
protection

3、Lamination customization service of LCD + TP.



LCM+RTP



LCM+CTP

4、Customization service of DWIN self-developed T5L ASIC+ LCD + TP.



5、Smart screen finished product customization.

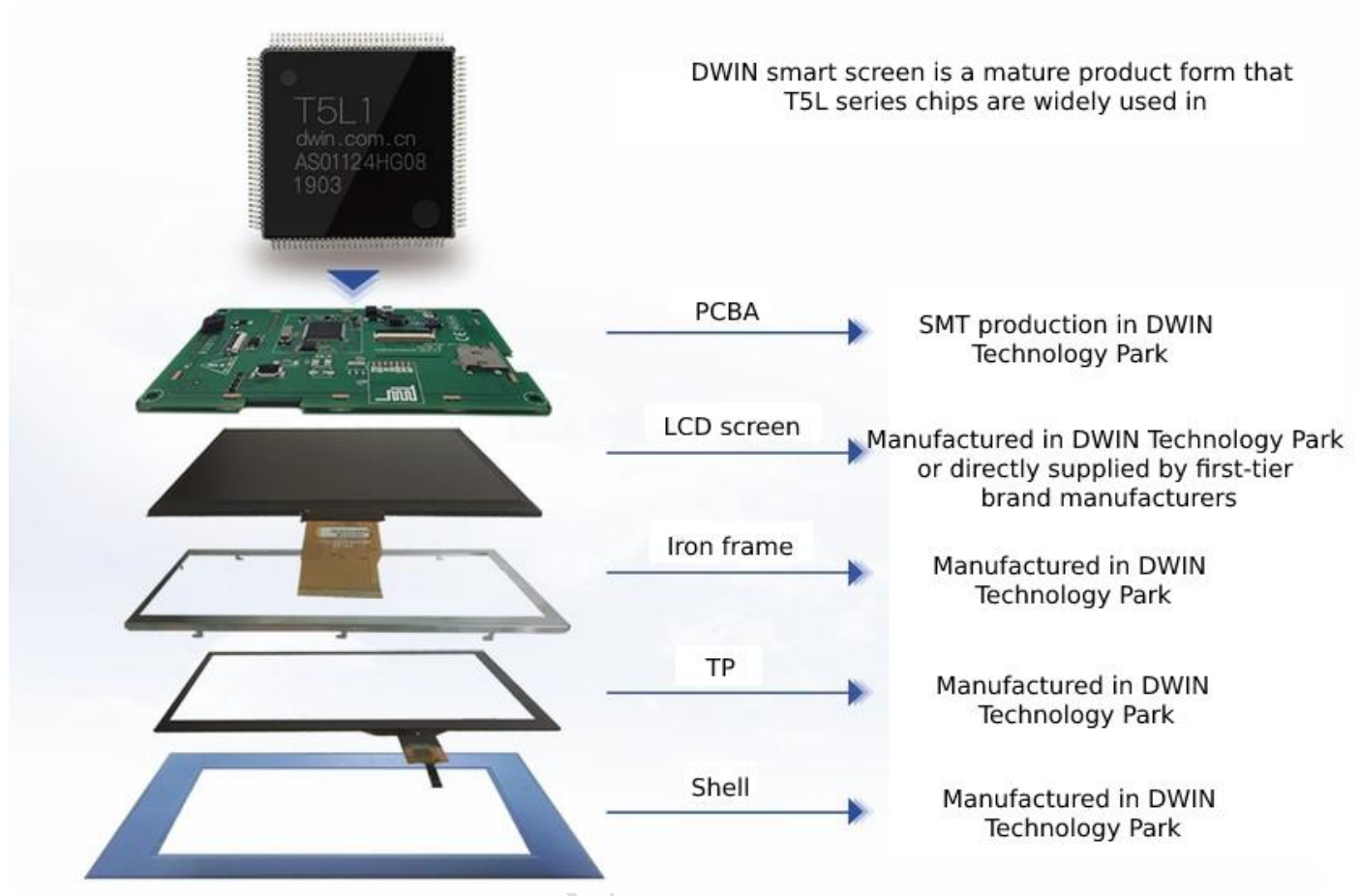

Please contact our sales staff for other customization needs.

Record of Revision

Rev	Date	Description	Editor
00	2020-11-16	First Release	Zhou Biao
01	2020-12-21	Update the Backlight Current	Zhou Biao
02	2020-12-28	Update the Driving Parameters	Zhou Biao
03	2022-07-20	Revise Drive Specifications	Zheng Yunjia
04	2022-12-22	Add Product Picture and Driver IC Update Operating Temp and Storage Temp	Chen Xian

Please contact us if you have any questions about the use of this document or our products, or if you would like to know the latest information about our products:

Customer service tel: +86 400 018 9008

Customer service email: dwinhmi@dwin.com.cn

DWIN developer forum: <https://forums.dwin-global.com/index.php/forums/>

Thank you all for continuous support of DWIN, and your approval is the driving force of our progress!