

DMG64480K035_03WN

产品特点:

- 基于 T5L1 芯片，运行 DGUS II 系统，医用级产品。
- 3.5 寸，640*480 分辨率，16.7M 色，IPS 屏，宽视角。
- 支持 RS232 与 RS485 通信。
- 带三防工艺。

Features:

- Based on T5L1, running DGUS II system, medical grade products.
- 3.5-inch, 640*480 pixels resolution, 16.7M colors, IPS-TFT-LCD, wide viewing angle.
- Support RS232 and RS485 communication.
- With conformal coating.



1、硬件及接口 Hardware and interface

1.1 硬件接口图 Hardware interface

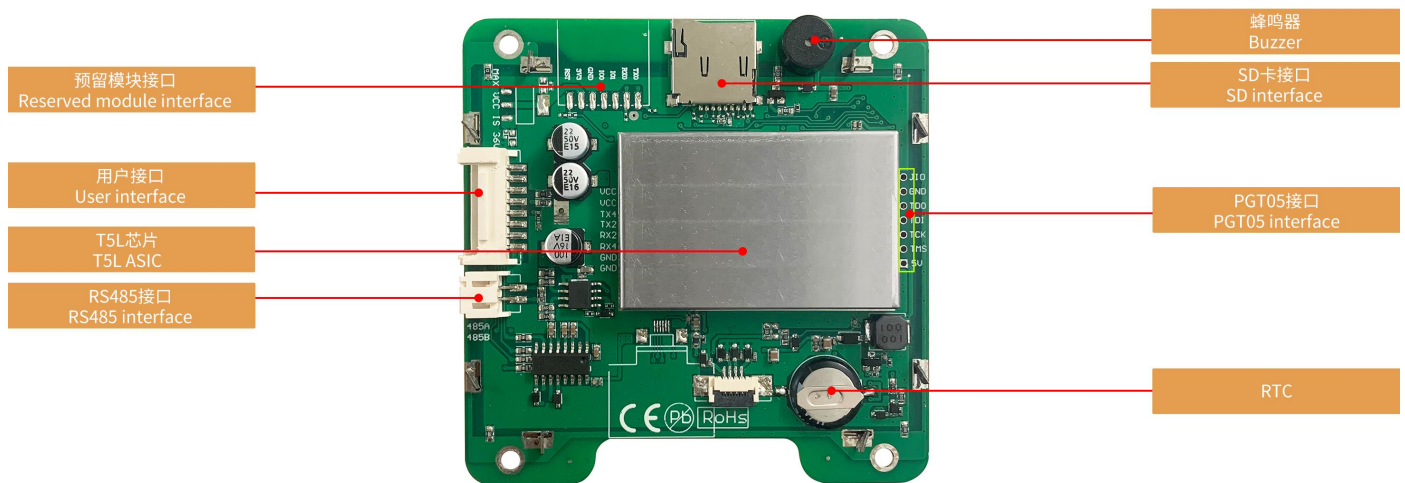

硬件接口图
Hardware interface

1.2 硬件及接口说明 Hardware and interface description

序号 No.	名称 Name	说明 Description
1	T5L1 芯片 T5L1 ASIC	迪文自主研发, 2019 年量产, 1MBytes 片内 Nor Flash, 其中 512KBytes 用于存储用户数据库, 擦写次数>100,000 次 Developed by DWIN. Mass production in 2019, 1MBytes Nor Flash on the chip, 512KBytes used to store the user database. Rewrite cycle: over 100,000 times
2	液晶屏接口 LCM interface	FPC40_0.5mm, MIPI 接口 FPC40_0.5mm, MIPI interface
3	用户接口 User interface	用于供电和串口通讯, 8Pin_2.0mm 座子。串口下载速率(典型值): 12KByte/s 8Pin_2.0mm socket for power supply and serial communication. Download rate(typical value): 12KByte/s
4	RS485 接口 RS485 interface	2Pin_2.0mm 卧式座子: 用于 RS485 通讯 2Pin_2.0mm horizontal socket: For RS485 communication
5	Flash	16MBytes NOR Flash, 存放字库、图片、音乐文件, 擦写次数>100,000 次 16MBytes NOR Flash, for fonts, pictures and audio files. Rewrite cycle: over 100,000 times
6	蜂鸣器 Buzzer	3V 无源蜂鸣器, 功率: <1W 3V passive buzzer. Power: <1W
7	RTC	法拉电容供电, 精度: $\pm 20\text{ppm} @ 25^\circ\text{C}$ 。掉电后可维持 7 天正常工作 Super-capacitor for power supply. Accuracy: $\pm 20\text{ppm} @ 25^\circ\text{C}$. It can work normally for 7 days after power failure
8	SD 卡接口 SD interface	FAT32 格式, 下载文件, 文件可在屏幕统计显示, 下载速率: 4Mb/s FAT32. Download files by SD interface can be displayed in statistics. Download rate: 4Mb/s
9	PGT05 接口 PGT05 interface	当产品因意外无法正常运行时, 可通过 PGT05 更新 DGUS 底层, 使产品重新恢复正常 When product crashes by accident, you can use PGT05 to update DGUS kernel and make the product return to normal

2、规格参数 Specification parameters

2.1 显示参数 Display parameters

显示屏类型 LCD Type	IPS, TFT LCD
视角 Viewing Angle	宽视角, 典型值 85°/85°/85°/85° (L/R/U/D) Wide viewing angle, 85°/85°/85°/85° (L/R/U/D)
分辨率 Resolution	640×480 (支持 0°/90°/180°/270°显示模式) 640×480 pixels (support 0°/90°/180°/270°)
色彩 Color	24 位 8R8G8B 24-bit 8R8G8B
AA 区 Active Area (A.A.)	70.08mm (W)×52.56mm (H)
VA 区 View Area (V.A.)	-
背光模式 Backlight Mode	LED
背光寿命 Backlight Service Life	>30000 小时 (以最高亮度连续工作, 亮度减半时间) >30000 hours (Time of the brightness decaying to 50% on the condition of continuous working with the maximum brightness)
背光亮度 Brightness	200nit
背光调节 Brightness Control	100 级亮度调节 (当亮度调节至最高亮度的 1%~30%时, 可能出现闪烁现象, 不建议在此范围使用) 0~100 grade (When the brightness is adjusted to 1%~30% of the maximum brightness, flickering may occur and is not recommended to use in this range)
<p>注: 超过 30 分钟长时间显示高对比度静止画面可能导致显示残影, 请增加屏保避免该问题。 Note: Long time display of high contrast still image over 30 minutes may lead to display residual shadow, please use screen saver to avoid this problem.</p>	

2.2 串口参数 Serial interface parameters

串口模式 Mode	UART2: RS232 UART4: RS232 (OS 配置后才能使用 Only available after OS configuration) UART5: RS485 (OS 配置后才能使用 Only available after OS configuration)				
串口 2、4 电平 Voltage Level	测试条件 Test Condition	最小值 Min	典型值 Typ	最大值 Max	单位 Unit
	Output 1	-	-5.0	-3.0	V
	Output 0	3.0	5.0	-	V
	Input 1	-15.0	-5.0	-	V
	Input 0	-	5.0	15.0	V
串口 2、4 波特率 Baud Rate	3150~3225600bps, 典型值: 115200bps 3150~3225600bps, typical value of 115200bps				
串口 5 电平 Voltage Level	测试条件 Test Condition	最小值 Min	典型值 Typ	最大值 Max	单位 Unit
	Output 1	2.5	5.0	-	V
	Output 0	-	-0.5	-2.5	V
	Input 1	0	2.5	-	V
	Input 0	-	-2.5	-0.2	V
串口 5 波特率 Baud Rate	3150~921600bps, 典型值: 115200bps 3150~921600bps, typical value of 115200bps				
数据格式 Data Format	UART2: N81 UART4: N81/E81/O81/N82 四种模式可选 (OS 配置) 4 modes (OS configuration) UART5: N81/E81/O81/N82 四种模式可选 (OS 配置) 4 modes (OS configuration)				
接口排线 Interface Cable	8Pin_2.0mm (RS232) 2Pin_2.0mm (RS485)				

2.3 电气规格 Electrical specifications

额定功率 Rated Power	<5W	
工作电压 Operating Voltage	6~36V, 典型值 12V 6~36V, typical value of 12V	
工作电流 Operating Current	260mA	VCC=12V, 背光亮度最大 VCC=12V, max backlight
	100mA	VCC=12V, 背光关闭 VCC=12V, backlight off
推荐工作电源: 12V 1A 的直流稳压电源 Recommended power supply: 12V 1A DC		

2.4 工作环境 Operating environment

工作温度 Operating Temperature	-20℃~70℃ (12V @ 60% RH)
存储温度 Storage Temperature	-30℃~80℃
工作湿度 Operating Humidity	10%~90%RH, 典型值 60%RH 10%~90%RH, typical value of 60% RH
三防漆工艺 Conformal coating	有 Yes
出厂前老化时间 Aging Test	72 小时 50℃ 环境高温带电老化 72 hours high temperature charged aging at 50℃

3、可靠性测试 Reliability test

3.1 静电放电测试 Electrostatic discharge test

测试环境温度：25°C，测试环境湿度：50%RH。

Test temperature: 25°C. Test humidity: 50%RH.

试验过程：将产品平置于测试台上，针对串口屏铁框和显示区域依次进行接触和空气放电，如下图 3.1 所示；实验过程观察屏幕有无死机、黑屏、白屏、花屏、重启等异常现象。性能符合判据 GB/T 17626.2 B 级及以上。

Test process: the product was placed on the test bench to perform contact and air discharge in turn of the serial screen iron frame and display area as shown in Fig.3.1 below. During the experimental process, it was observed whether the screen is dead, black, white, splash, or reboot. According to the experiment results, the performance is in line with the criteria GB/T 17626.2 B level and above.



3.1 静电放电测试图

Electrostatic discharge test

放电类型 Discharge Type	放电值 Discharge Value	结果 Result
接触放电 Contact discharge	±8KV	正常工作 Normal operation
空气放电 Air discharge	±15KV	正常工作 Normal operation

3.2 电快速瞬变脉冲群 EFT 测试 EFT test

测试环境温度：25°C，测试环境湿度：50%RH。

Test temperature: 25°C. Test humidity: 50%RH.

试验过程：将产品平置于测试台上，通过脉冲群发生仪耦合脉冲群后的电源对智能屏进行供电如下图 3.2 所示；实验过程观察屏幕是否出现复位重启、异常显示、触摸异常等现象，性能符合 GB/T 17626.4 B 级及以上。

Test process: the product was placed on the test bench to perform contact and the smart screen is energized by the power supply coupled with a EFT generator as shown in Fig. 3.2 below. During the experimental process, it was observed whether abnormal reset, display or touch phenomena occurs. According to the experiment results, the performance is in line with the criteria GB/T 17626.2 B level and above.



3.2 群脉冲测试图
 EFT test

测试项目 Test Item	测试标准 Test Standard	结果 Result
电源端口 Power supply	±2KV;100KHz	正常工作 Normal operation

3.3 传导干扰测试 CE test

测试项目 Test Item	测试标准 Test Standard	结果 Result
传导干扰 CE	ClassB-6dB	正常工作 Normal operation

LINE

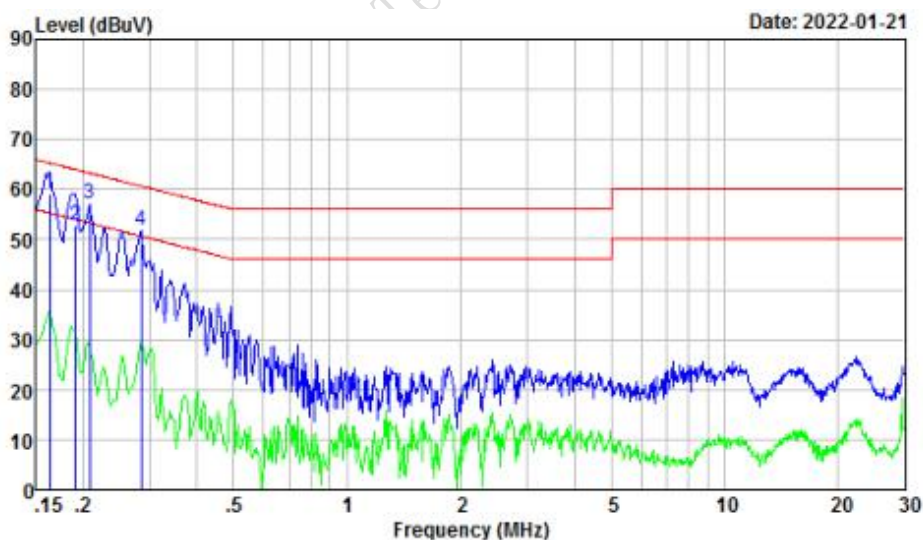

Freq MHz	Reading level dBuV	LISN/ISN factor dB	Cable loss dB	Result level dBuV	Limit level dBuV	Over limit dB	Remark
0.163	49.70	9.55	0.01	59.26	65.30	-6.04	QP
0.190	43.40	9.56	0.01	52.97	64.02	-11.05	QP
0.208	47.44	9.56	0.01	57.01	63.27	-6.26	Peak
0.285	42.26	9.57	0.01	51.84	60.68	-8.84	Peak

NEUTRAL

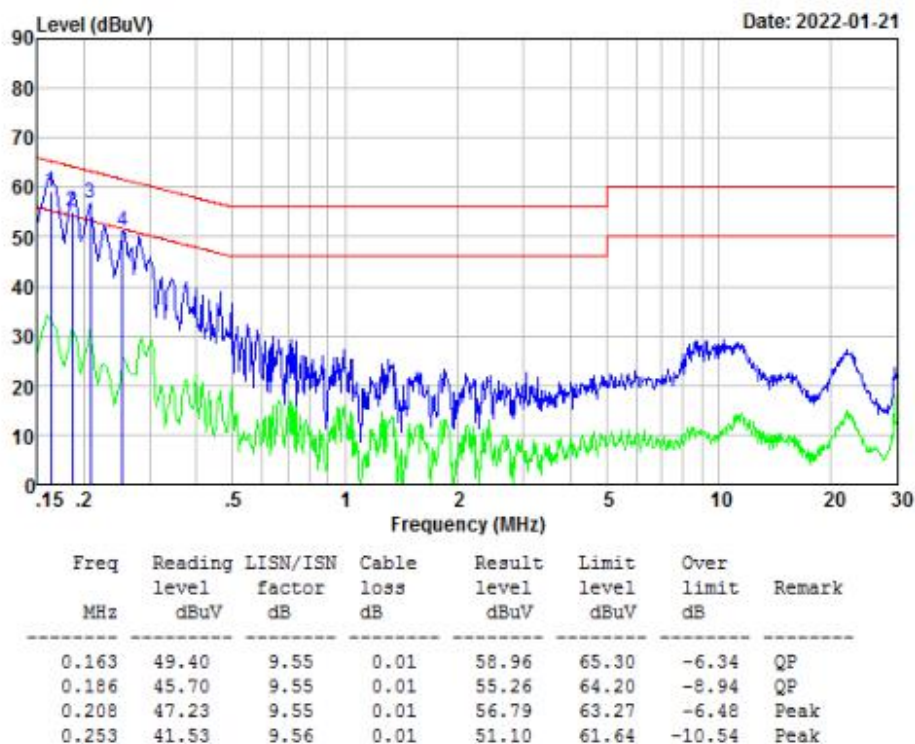

3.4 辐射干扰测试 RE test

测试项目 Test Item	测试标准 Test Standard	结果 Result
辐射干扰 RE	ClassB-6dB	正常工作 Normal operation

HORIZONTAL

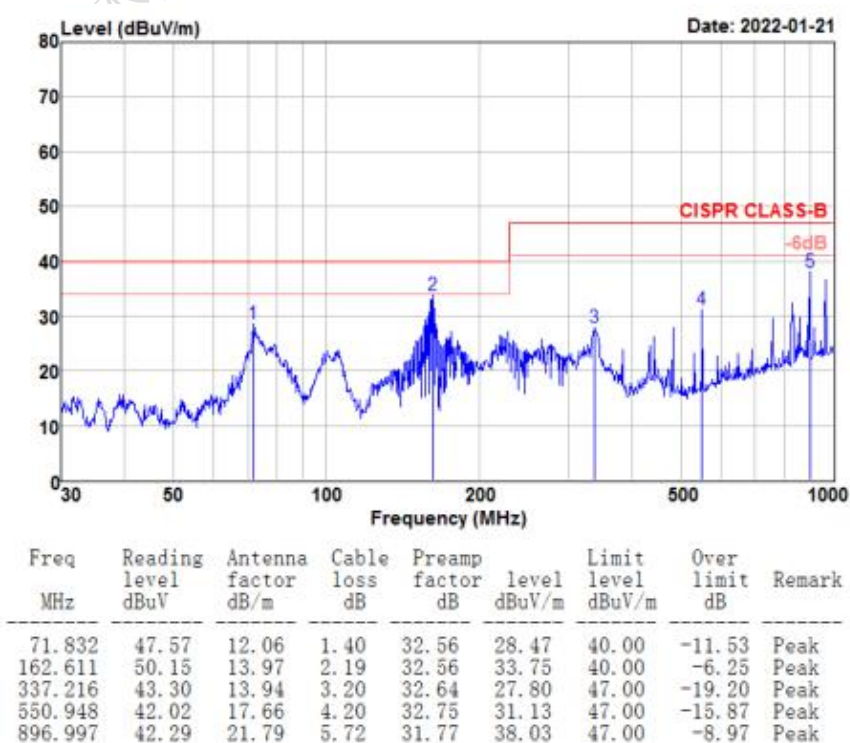

VERTICAL

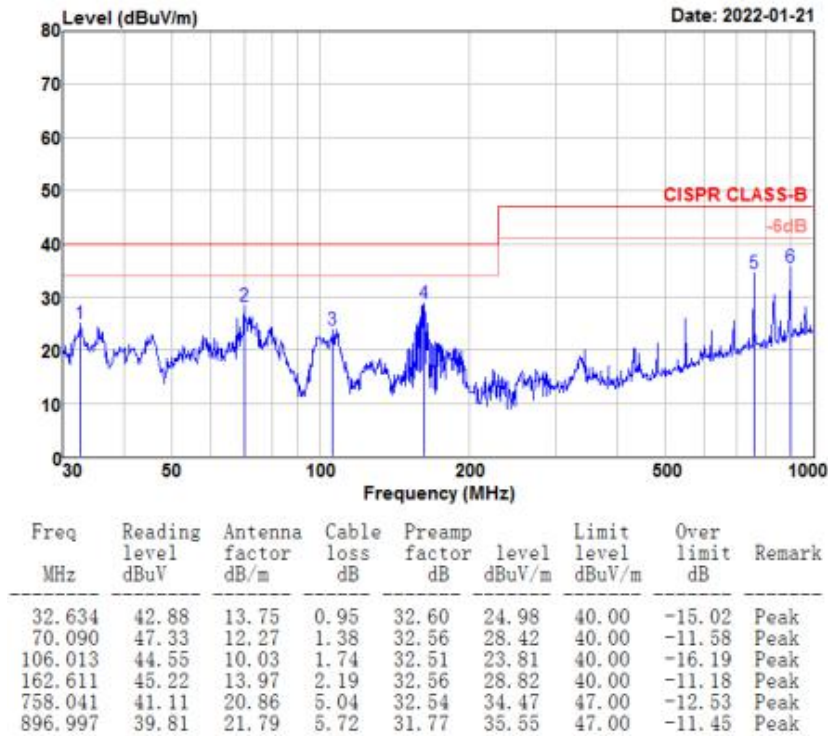

3.5 传导骚扰抗扰度测试 CS test

- Test standard : EN 61000-4-6:2014 IEC 61000-4-6:2013 GB/T 17626.6-2017
- Other:
- Modulation: Amplitude 80%,1kHz sine wave Amplitude 80%,2Hz sine wave Other:
- Dwell time: 1s 3s other:
- Frequency Step Size : 1 % of preceding frequency value other:

Coupling Line	Frequency Range (MHz)	Voltage Level(e.m.f.) (V)	Result
电源端	0.15-80	10	A

3.6 浪涌（冲击）测试 SURGE test

- Test standard : EN 61000-4-5:2014+A1:2017 IEC 61000-4-5:2014+A1:2017 GB/T 17626.5-2019
- Other:

Table 1: _____DC_____ mains power input port

Level	Voltage	Polarity	Path	Result
1	0.5kV	±	/	/
2	1kV	±	正极对负极	A
3	2kV	±	/	/
4	4kV	±	/	/

3.7 射频电磁场辐射抗扰度测试 RS test

- Test standard : EN 61000-4-3:2006+A1:2008+A2:2010 IEC 61000-4-3:2006+A1:2007+A2:2010
 ■ GB/T 17626.3-2016 other:
- Modulation: ■ Amplitude 80%,1kHz sine wave Amplitude 80%,2Hz sine wave Other:
- Dwell time: ■ 1s 3s other:
- Frequency Step Size : ■ 1 % of preceding frequency value other:

Frequency range (MHz)	Field strength (V/m)	Front side		Rear side		Left side		Right side	
		VER	HOR	VER	HOR	VER	HOR	VER	HOR
80-1000	10	A	A	A	A	A	A	A	A

性能标准:

- A.在制造商、委托方或购买方规定的限值内性能正常;
- B.功能或性能暂时丧失或降低,但在骚扰停止后能自行恢复,不需要操作者干预;
- C.功能或性能暂时丧失或降低,但需操作者干预才能恢复;
- D.因设备硬件或软件损坏,或数据丢失而造成不能恢复的功能丧失或性能降低。

Performance Criterion:

- A. Normal performance within limits specified by the manufacturer, requestor or purchaser;
- B. Temporary loss of function or degradation of performance which ceases after the disturbance ceases, and from which the equipment under test recovers its normal performance, without operator intervention;
- C. Temporary loss of function or degradation of performance, the correction of which requires operator intervention;
- D. Loss of function or degradation of performance which is not recoverable, due to damage to hardware or software, or loss of data.

4、包装和物理尺寸 Packaging & dimensions

外形尺寸 Form Factor	82.0mm (W)×82.0mm (H)×13.6mm(T)			
安装尺寸 Installation Dimensions	开孔尺寸: 77.8(+0.3mm)×64.8(+0.3mm) Positioning hole: 77.8(+0.3mm)×64.8(+0.3mm)			
净重量 Net Weight	80g			
包装标准 Packaging Standards				
包装箱型号 Model	包装箱尺寸 Dimensions	层数 (层) Layer	数量/层 (片) Quantity/Layer	总数量 (片) Quantity(Pcs)
1 号箱 Carton1:	220mm(L)×160mm(W)×47mm (H)	1	2	2
2 号箱 Carton2:	250mm(L)×200mm(W)×80mm (H)	2	2	4
3 号箱 Carton3:	320mm(L)×270mm(W)×80mm (H)	2	4	8
4 号箱 Carton4:	435mm(L)×335mm(W)×290mm(H)	-	-	-
5 号箱 Carton5:	600mm(L)×430mm(W)×290mm(H)	2	60	120

声明: 产品设计改善或变更, 不单独另行通知。

Disclaimer: The product design is subject to alternation and improvement without prior notice.

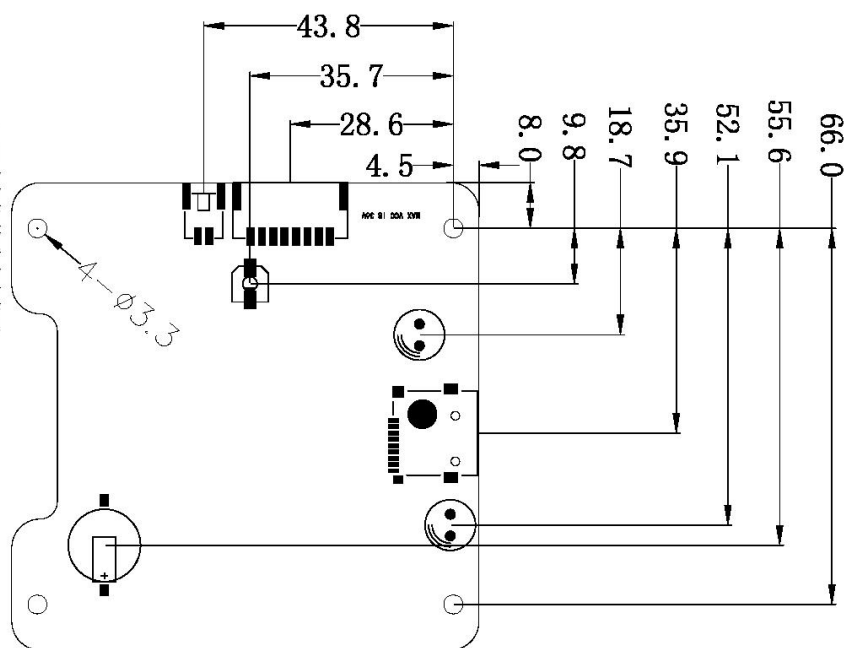
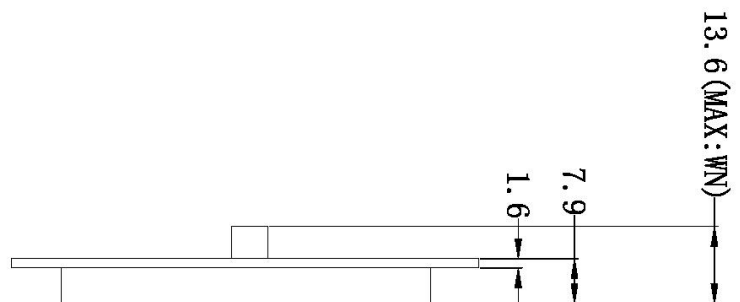
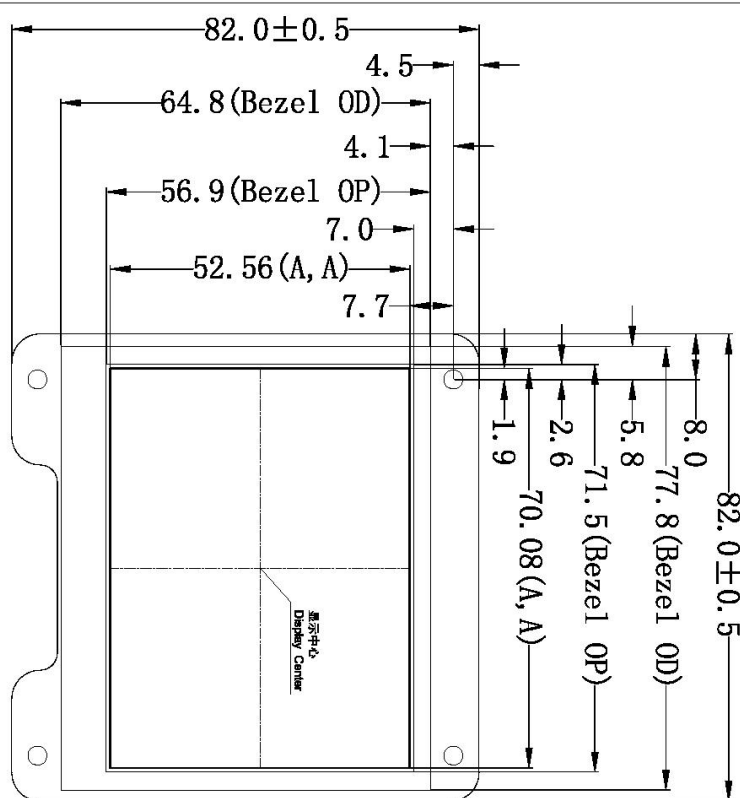

1. 尺寸定位基准为定位孔
 Location hole is used as position reference.
 2. 未标注公差为 $\pm 0.3\text{mm}$
 Unmarked Tolerance is $\pm 0.3\text{mm}$
 注: 虚线标注为有效显示区域
 Active area is marked in Dash lines

定义 Definition	序号 Pin#	类型 Type	说明 Description
VCC	1, 2	P	电源输入 Power Input
TX4	3	O	串口4输出 Output
TX2	4	O	串口2输出 Output
RX2	5	I	串口2输入 Input
RX4	6	I	串口4输入 Input
GND	7, 8	P	公共接地 GND

型号 Model	图纸 Drawing	比例 Scale	单位 Unit
DMG64480K035-03WN	A 4	1:1	MM

图纸 Drawn	日期 Date	图纸 Drawn	日期 Date
J. G	20220220	J. G	20220220

审核 Review	日期 Date	批准 Approval	日期 Date

迪文科技
 DWIN Technologies

5、调试工具 Debugging tools

建议首次使用迪文智能屏的用户购买标准配件。详细信息可联系客服人员。

It is recommended for new users of DWIN smart LCMs to purchase official accessories. For more details, please refer to customer service center.

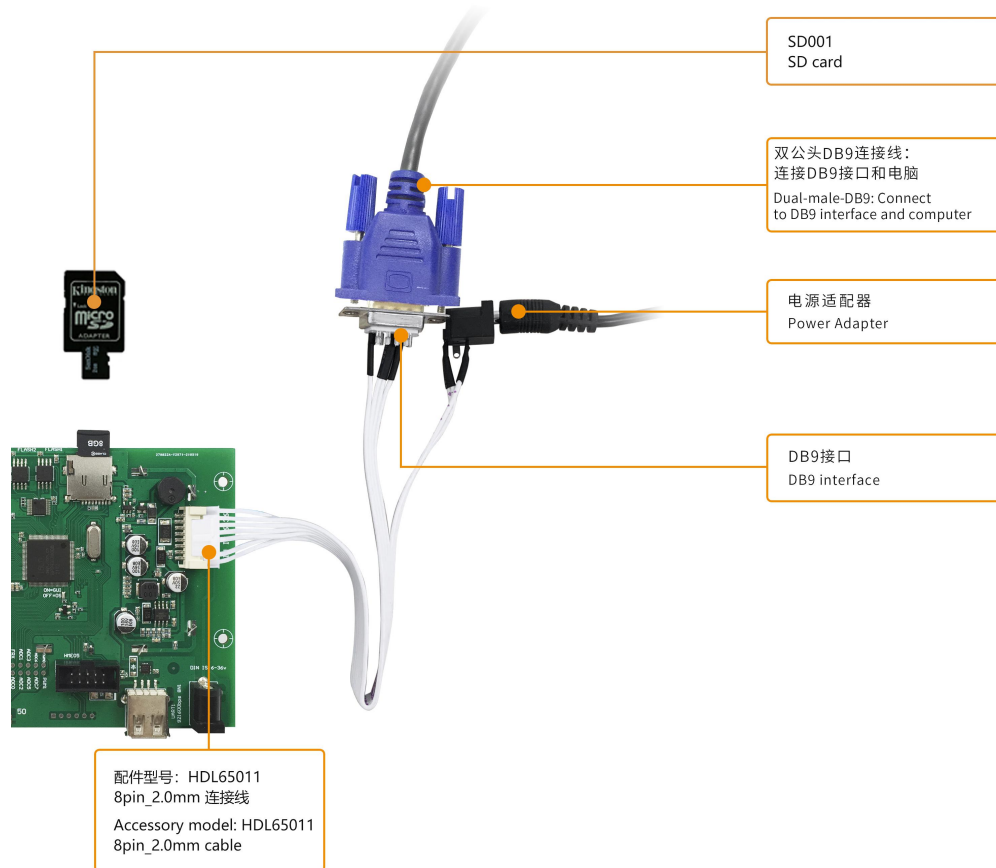

6、T5L 系列芯片特点 T5L series IC features

(1) 采用应用最广泛、成熟和稳定的 8051 核，1T（单指令周期）高速工作，最高主频 250MHz。

Mature and stable 8051 core which is the most widely used with the maximum operating frequency of T5L is up to 250MHz, 1T(single instruction cycle)high speed operation.

(2) 单独 CPU 核（GUI CPU）运行 DGUS II 系统：

Separate GUI CPU Core running DGUS II System:

- 内置高速显存，2.4GB/S 带宽。

High-speed display memory, 2.4GB/S bandwidth.

- 2D 硬件加速，JPEG 解压缩速度高达 200fps@1280*800，UI 极其流畅。

2D hardware acceleration, the decompression speed of JPEG is up to 200fps@1280*800 and the UI with animation and icons as its main feature is extremely cool and smooth.

- JPEG 压缩模式存储图片、图标，大幅度缩小外置存储器到低成本的 16Mbytes SPI Flash。

Images and icons stored in JPEG format. Adopt Low-cost 16Mbytes SPI Flash.

- 支持电阻或电容触摸屏，灵敏度可以调节，最快 400Hz 触控打点速度。

Support CTP or RTP with adjustable sensitivity and maximum 400 Hz touch frequency.

- 1 路 15bit 32Ksps PWM 数字功放驱动扬声器，实现高品质语音压缩存储和播放。

1-way 15bit 32Ksps PWM digital power amplifier driver loudspeaker, save power amplifier cost and achieve high signal-to-noise ratio and sound quality restoration.

- 128Kbytes 变量存储器空间，存储器接口和 OS CPU 核交换数据，应用及其简单。

128Kbytes variable storage space for exchanging data with OS CPU Core and memory.

- 支持 PC 端组态开发和仿真，支持后台远程升级。

Support DGUS development and simulation on PC. Support background remote upgrade.

(3) 单独 CPU 核（OS CPU）运行用户 8051 代码，应用中省掉用户 CPU：

Separate CPU (OS CPU) core runs user 8051 code or DWIN OS system and user CPU is omitted in practical application:

- 标准 8051 架构和指令集，64Kbytes 代码空间，32Kbytes 片内 RAM。

Standard 8051 architecture and instruction set, 64Kbytes code space, 32Kbytes on-chip RAM.

- 64bit 整数型数学运算单元（MDU），包括 64bit MAC 和 64bit 除法器。

64 bit integer mathematical operation unit (MDU), including 64 bit MAC and 64 bit divider.

- 28 个 IO，4 路 UARTs，1 路 CAN 接口，最多 8 路 12bit A/D，2 路 16bit 分辨率可调的 PWM。

28 IOs, 4-channel UARTs, 1-channel CAN, up to 8-channel 12-bit A/Ds and 2-channle 16-bit PWM of adjustable resolution.

- 支持 IAP 在线仿真和调试，断点数量无限制。

Support IAP on-line simulation and debugging with unlimited number of breakpoints.

- 可以透过 DGUS 系统在线升级代码。

Upgrade code online through DGUS system.

- (4) 1Mbytes 片内 Flash, 迪文专利加密技术, 确保代码和数据安全, 杜绝山寨和克隆。

1Mbytes on-chip Flash with DWIN patent encryption technology ensure code and data security.

- (5) -40°C~+85°C工作温度范围 (可定制 -55°C~105°C工作温度范围 IC)。

Operating temperature ranges from -40°C to +85°C (IC operating temperature customizable from -55°C to 105°C).

迪文欢迎广大用户基于 T5L 自主设计客制化产品。

DWIN encourages users to design your own customized product based on T5L.

7、修订记录 Revision records

版本 Rev	日期 Revise Date	描述 Content	编辑人 Editor
00	2022-02-23	首次发布 First Edition	郑运佳

使用本文档或迪文产品过程中如存在任何疑问，或欲了解更多迪文产品最新信息，请及时与我们联络：

Please contact us if you have any questions about the use of this document or our products, or if you would like to know the latest information about our products:

客服电话 Customer service Tel: 400 018 9008

客服 QQ Customer service QQ: 400 018 9008

客服邮箱 Customer service email: dwinhmi@dwin.com.cn

迪文开发者论坛 DWIN Developer Forum: <http://forum.dwin.com.cn>

感谢大家一直以来对迪文的支持，您的支持是我们进步的动力！

谢谢大家！

Thank you all for continuous support of DWIN, and your approval is the driving force of our progress!